



Arms, Brackets & Bars

Generally used in conjunction with clamps and stands to provide precise positioning of lighting and lighting control equipment. The range includes the Magic Arm and the Variable Friction arm, which have become indispensable in virtually any situation from ball and socket arms for the smallest flag to side arms for rigging heavy lampheads.

The LS.196 series of articulated arms have been completely revised with a new sliding mechanism. This is also used on a completely new family of double tube arms giving the perfect combination of lightness, strength and rigidity for loads up to 5kg.



3

Arms, Brackets & Bars

ARRI arms, brackets & bars for accurate positioning.

- Wherever you need to position your camera, light or accessory, we have an arm, a bracket or a bar to fit the task.
- Can be combined with clamps, mounting plates and connectors and used in conjunction with virtually any product in the ARRI range.

LS.143.KIT

MAGIC ARM KIT

- 📏 2.55kg
- 📏 Type 17
- 📏 Type 17 + Camera Bracket LS.143.BKT
- 📏 3kg

Articulated arm with centre lever to lock all 3 movements.
Length: 53cm.
Supplied with: Camera/Umbrella Bracket LS.143.BKT, Super Clamp LS.035, Backlite Base LS.003.



LS.244

VARIABLE FRICTION ARM WITH CAMERA BRACKET

- 📏 1.09kg
- 📏 Type 17
- 📏 Type 17 + Camera Bracket LS.143.BKT
- 📏 3kg

Features as LS.143A, but a large locking knob takes the place of the cam-lever. Variable friction and locking of arm obtained by adjusting knob. Comes complete with Camera/Umbrella Bracket LS.143.BKT only.

LS.244N not illustrated

VARIABLE FRICTION ARM

Friction arm only, no accessories.

LS.143A

MAGIC ARM WITH CAMERA BRACKET

- 📏 1.07kg
- 📏 Type 17
- 📏 3kg
- 📏 Type 17 + Camera Bracket LS.143.BKT

Magic arm with camera bracket only.

LS.143N not illustrated

MAGIC ARM

Magic arm only, no accessories.

LS.143.BKT not illustrated

CAMERA/UMBRELLA BRACKET

Camera bracket only.



LS.143R

MAGIC ARM WITH SUPER CLAMP

- 📏 1.5kg



LS.237

FLEX ARM

 0.3kg

 Type 18

 16mm

Flexible arm, Ø 13mm, 55cm long with hexagon stud to fit Super Clamp LS.035 with 3/8" female thread and 16mm stud with 1/4" male thread type 18.



LS.237HD

HEAVY DUTY FLEX ARM

 0.3kg

 Type 18

 16mm

Same as LS.237, but Ø 18mm.



LS.196BASE

BASE FOR ARTICULATED ARM

 2.2kg

 Type 1

Floor desk base for LS.196, LS.143, LS.237, LS.237.HD and LS.244.



3

Arms, Brackets & Bars

LS.196 Single Articulated Arms

LS.196AB.2

SINGLE ARTICULATED ARM, 2 SECTIONS

2 sections.

Top attachment, 16mm spigot 3/8" light attachment.

Bottom attachment, 16mm spigot (compatible with Superclamp) with 1/4" thread.

Max Length 605mm

Max load at full extension 1.5kg

Weight 0.4kg



LS.196AB.3

SINGLE ARTICULATED ARM, 3 SECTIONS

3 sections.

Top attachment, 16mm spigot 3/8" light attachment.

Bottom attachment, 16mm spigot (compatible with Superclamp) with 1/4" thread.

Max Length 850mm

Max load at full extension 1kg

Weight 0.5kg



LS.196B.2

SINGLE ARTICULATED ARM, 2 SECTIONS,
WITH CAMERA BRACKET

2 sections.

Top attachment, camera bracket with 16mm spigot and camera attachment.

Bottom attachment, 16mm spigot (compatible with Superclamp) with 1/4" thread.

Max Length 605mm

Max load at full extension 1.5kg

Weight 0.53kg



LS.196B.3

SINGLE ARTICULATED ARM, 3 SECTIONS,
WITH CAMERA BRACKET

3 sections.

Top attachment, camera bracket with 16mm spigot and camera attachment.

Bottom attachment, 16mm spigot (compatible with Superclamp) with 1/4" thread.

Max Length 850mm

Max load at full extension 1kg

Weight 1.53kg



LS.396 Double Articulated Arms

LS.396AB.2

DOUBLE ARTICULATED ARM, 2 SECTIONS

2 sections.

Top attachment, 16mm spigot 3/8" light attachment.

Bottom attachment, double-anchored 16mm hexagonal/universal spigot.

Max Length 625mm

Max load at full extension 5kg

Weight 0.5kg



LS.396AB.3

DOUBLE ARTICULATED ARM, 3 SECTIONS

3 sections.

Top attachment, 16mm spigot 3/8" light attachment.

Bottom attachment, double-anchored 16mm hexagonal/universal spigot.

Max Length 860mm

Max load at full extension 4.5kg

Weight 0.79kg



LS.396B.2

DOUBLE ARTICULATED ARM, 2 SECTIONS,
WITH CAMERA BRACKET

2 sections.

Top attachment, camera bracket with 16mm spigot and camera attachment.

Bottom attachment, double-anchored 16mm hexagonal/universal spigot.

Max Length 625mm

Max load at full extension 5kg

Weight 0.64kg



LS.396B.3

DOUBLE ARTICULATED ARM, 3 SECTIONS,
WITH CAMERA BRACKET

3 sections.

Top attachment, camera bracket with 16mm spigot and camera attachment.

Bottom attachment, double-anchored 16mm hexagonal/universal spigot.

Max Length 860mm

Max load at full extension 4.5kg

Weight 0.90kg



3

Arms, Brackets & Bars

ARRI arms, brackets & bars for accurate positioning.

LS.039

"U" HOOKS

0.16kg



Set of two cross bar holders.
Width: 40mm.

LC.9000.A

"U" HOOKS

As above but for 2" bar.

LS.042

EXTENSION ARM

GC

0.21kg

8kg

Type 1 + Spigot Art. LS.013

Fits into Super Clamp LS.035 socket.
Length: 19.5cm.



LS.133

EXTENSION BAR

B

0.1kg

Used to fix 2 Super Clamps LS.035
at a distance of 15cm from each other.
Length: 16.5cm.



LS.040

NARROW "U" HOOKS

0.44kg

Set of two narrow "U" cross bar holders.
Plugs into Super Clamp 035.
Width: 15mm.



LS.154

MICROPHONE SUPPORT

B

0.79kg

16mm + Spigot Art. 013

16mm

65cm long T Bar with 3 x 16mm sockets
plus 3 x 16mm Spigot Art. LS.013.
Designed to fit on stand or bracket
with 16mm pin.



LS.169

FIVE SOCKET BRACKET

6.10kg

28mm

28mm

100cm long T Bar with 5 x 28mm sockets
for attaching up to 5 lighting fixtures.
Designed to fit on stand or bracket with
28mm socket.

LS.135

LIGHTING GANTRY BAR

B

0.9kg

For mounting lighting fixtures.
Length: 2m.
To be fixed between 2 Autopoles®
by means of Narrow "U" Hooks LS.040.
Measurements: 200 x 3.5 x 1.5cm.



LF.9000.A

BABY TRIPLE HEADER
5 x 16mm PIN & 16mm SOCKET

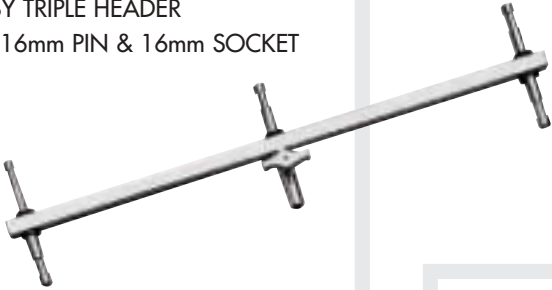

i 1.3kg

Length: 100cm.

LF.6000.A

BABY OFFSET ARM/TWIN **B AC**
16mm PIN & 16mm SOCKET

i 0.7kg

Length: 38cm.



LF.12000.A

COLUMN ARM

i 3.1kg

U 28mm

1 Type 33

Length: 51cm.

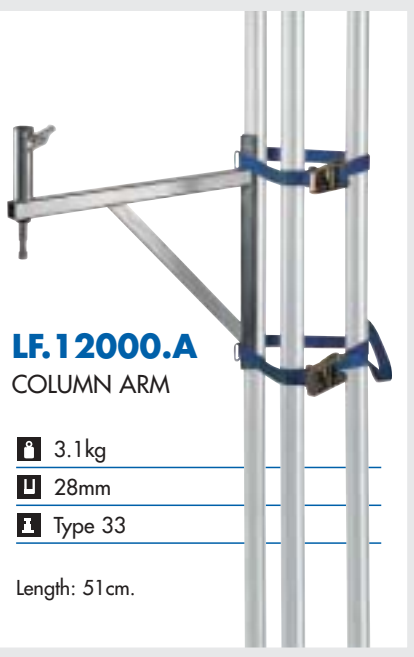

LF.2000.A

JUNIOR ADJUSTABLE SIDE
ARM-28mm SOCKET

i 2.1kg

Length: 41cm.



LF.7000.A

BABY SIDE ARM TWIN 16mm PIN **B AC**

i 2.1kg

Length: 38cm.



LF.1000.A

JUNIOR OFFSET ARM-28mm
PIN & 28mm SOCKET

i 1.5kg

Length: 50cm.



3

Arms, Brackets & Bars

ARRI arms, brackets & bars for accurate positioning.

LI.8000.A

BLACK METAL FLAG

 0.29kg

Thickness: 1mm.

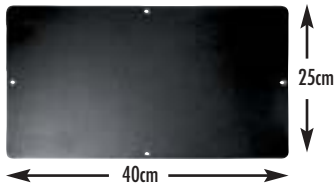

LI.8010.A

BLACK PLASTIC FLAG

 0.15kg

Thickness: 3mm.

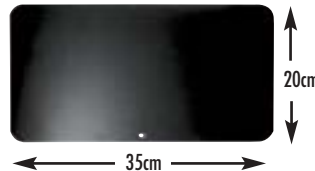

LD.5080.A

UNIVERSAL ARTICULATED ARM KIT

 1.22kg

Articulated Arm, Mini Clamp, 3/8" Square Adapter, 10mm Socket Adapter, Super Clamp, Hexagonal Adapter, Black Plastic Flag.
Arm length: 90cm.

LD.5060.A

BALL AND SOCKET FLAG ARM

 0.32kg

Length: 43cm.

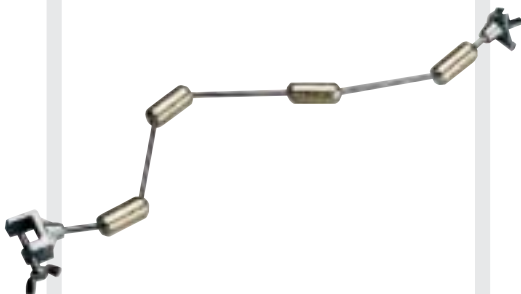

LD.3090.A

UNIVERSAL FLEXTENTION KIT

 1.15kg

Comprising: Flextension Arm, Mini Clamp, 3/8" Square Adapter, 10mm Socket Adapter, Super Clamp, Hexagonal Adapter, Black Plastic Flag.
Arm length: 50cm.



LD.3040.A

CAMERA FLEXTENTION KIT

 0.6kg

Flextension Arm, with 2 Mini Clamps, 3/8" Adapter, 10mm Socket Adapter, Black Plastic Flag.





LD.3001.A

SNAP IN ARTICULATED ARM

0.63kg

0.35kg

Length: 78cm.

LD.3006.A

not illustrated

ARTICULATED ARM
WITH HEXAGONAL END

Similar to the LD.3001.A but with a hexagonal attachment at one end and a 16mm pin at the other.

LD.3010.A

MINI-FLEX ARM

0.09kg

Flexible arm, Ø 10mm. Length: 11cm.
Attachment: bushing and stud 6mm diam.



LC.3030.A

FIXED BABY SIDE ARM

1.37kg

20kg

Type 33

Clamps on diameters from 48mm to 52mm.
Length: 44cm.



LC.3035.A

FIXED JUNIOR SIDE ARM

1.42kg

20kg

28mm

Clamps on diameters from 48mm to 52mm.
Length: 47cm.

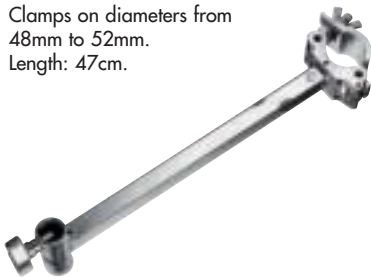

LD.3000.A

ARTICULATED ARM WITH
SPRING CLAMP

0.85kg

0.25kg

Length: 91cm.



LD.3015.A

MAXI-FLEX ARM

0.16kg

Flexible arm, Ø 15mm.
Length: 12,5cm.
Attachment: bushing and stud 10mm diam.

