



Lighting Booms

Lighting booms provide the ideal unobtrusive way to position lighting and reflector gear directly above the subject.



Lighting Booms

It is all a question of balance.

- Boom arms allow you to position your lights in the most difficult positions.
- Strong steel or tubular aluminium construction; counterweighted for smoothness of operation and stability.
- Our considerable range allows you to choose the length, load capacity and support type that suits you, whether you're working from the ground on lighting stands, or directly from the wall or ceiling.



LS.425B

MEGA BOOM (STAND NOT INCLUDED)

- 15kg
- ▼ 6kg at maximum extension
- ▮ 16mm/28mm
- GC

Largest boom in the range, remote control of pan, tilt and rotation of lamina plus geared telescopic extension. Combination of black zinc steel and black anodised aluminium tubes. 2 section (Ø: 45, 55mm).



LS.085BSL - BLACK not illustrated LS.085SL - SILVER

LIGHT BOOM 35 (STAND NOT INCLUDED)

- 8.9kg
- ▼ 6kg at maximum extension
- ▮ Type 25 + Spigot LS.013

Ø 35mm. 3 section boom arm complete with Pivoting Clamp LS.123, CounterWeight LS.022, cable clips and locking key.



LS.025BS - BLACK LS.025 - SILVER not illustrated

SUPERBOOM (STAND INCLUDED)

- 10.8kg
- ▼ 5kg at maximum extension
- ▮ Type 17 + Rapidapter LS.014-38

Ø 35mm. 1 section boom complete with Pivoting Clamp LS.123, Counter Weight LS.022, cable clips. Load: 5kg at 200cm with 20kg counterweight.

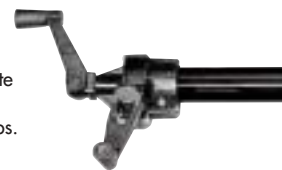

Folded length: 220cm.
 Min. extension from stand attachment: 50cm.
 Max. extension from stand attachment: 320cm.
 Suggested stand: Wind-Up series.



Load: 6kg at 230cm with counterweight.
 Weight: 2.2kg, boom only.
 Dismantled length: 100cm. Assembled: 280cm.



LS.025BSL - BLACK **LS.025SL - SILVER** not illustrated
 SUPERBOOM (STAND NOT INCLUDED)

Weight: 4.1kg, boom only.
 Remote control of lighting movement.
 270cm long.



Lighting Booms

It is all a question of balance.

LS.024

B

LIGHT BOOM (STAND NOT INCLUDED)

 5.7kg

 Type 25 + Spigot LS.013



Boom attaches to the shaft of most light stands with diameters of 19, 20, 25, 28mm.
 Ø: 25mm 3 sections boom arm complete with Pivoting Clamp LS.124, counterweight LS.023, cable clips and locking key.
 Weight: 1.4kg (boom only).
 Load: 3kg at 170cm with counterweight.
 Dismantled length: 71cm.
 Assembled length: 200cm.

LS.254

B

AUTOBOOM (STAND NOT INCLUDED)

 5.3kg

 Type 25 + Spigot LS.013 + Type 37

Boom arm for heavy stand or wall bracket mounting featuring self balancing spring system.
 Maximum load: 4kg at Maximum extension, 8kg at minimum extension. Supplied with wall bracket.
 Minimum extension: 110cm. Maximum extension: 200cm.



Wall Bracket included

LS.025TM

SUPER BOOM WITH COLUMN STAND

 18.5kg

 Type 17 + Rapidapter LS.014-38



Ø 35mm. 1 section boom arm complete with Pivoting Clamp LS.123, Counterweight LS.022, Cable Clips and Column Stand with casters.
 Load: 5kg at 200cm with 20kg of counterweight.
 Weight: 4.1kg, boom only.
 170cm long.

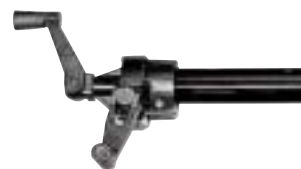

LS.098

B

WALL BOOM

 2.3kg

 Type 25 + Spigot LS.013

Wall mounted boom arm. 2 section (Ø 35, 29mm).
 Rotation: 160° vertically and 180° horizontally.
 Load, at full extension: 4.5kg.
 Minimum extension: 120cm. Maximum extension: 210cm.





LS.098SH

SHORT WALL BOOM

B

A 2kg

U Type 25 + Spigot LS.013

Load: 5kg.
Min. extension: 78cm.
Max. extension: 122cm.



Lighting Booms

It is all a question of balance.

LS.173MB

MINI BOOM



 0.32kg

 Type 18 and Type 19

Boom shaft Ø: 20mm. Length: 109cm.



LS.173HO

LONG MINI BOOM

not illustrated



Long version of LS.173.MB
Length: 150cm.

LD.5070.A

EXTENSION ARM WITH SWIVEL PIN



 1.1kg

 Type 33

Arm Length: 91cm.

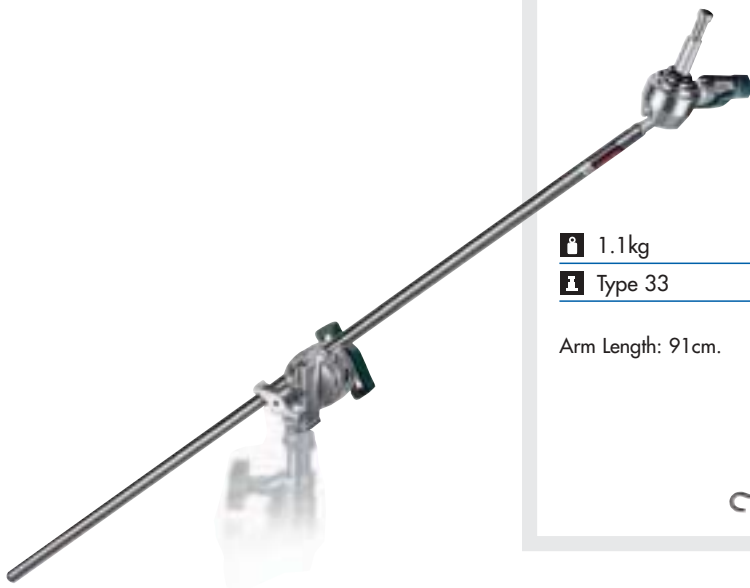

LD.6000.A

MINI BOOM



 3.6kg

 Type 33

Min extension 117cm - Max load 30kg.
Max extension 212cm - Max load 7kg.



LD.6500.A

JUNIOR BOOM ARM



 14.8kg

 Type 34

Min extension 163cm - Max load 40kg.
Max extension 300cm - Max load 10kg.



LS.123

PIVOTING BOOM CLAMP

 0.72kg

Pivoting clamp for Ø 35mm boom shaft
Ø 28mm male and Ø 16mm attachment.



LS.022

MAXI COUNTERWEIGHT

 6.7kg

Counterweight.
Clamps on Ø 22mm to 35mm.

LS.023 not illustrated
COUNTERWEIGHT

 4.3kg



LS.172

COUNTERWEIGHT

 1.3kg

Clamps on bars from Ø 13mm to 30mm.



LD.6010.A

C-BOOM/FISHPOLE HOLDER

 0.62kg

For tubes of max
diameter 35mm.



LE.7000.A

BABY DROP DOWN PIN

 0.62kg

 16mm

 16mm

For more accurate light positioning:
it helps keep the light in horizontal
position independently of the angle of the
boom. Specifically designed to be used
on boom arm with light attachment with
16mm pin (e.g., LD.6000.A).



LE.7010.A

JUNIOR DROP DOWN PIN

 1.32kg

 Type 34

 Type 35

Same as LE.7000.A, designed
to be used on boom arm with 28mm
bushing (e.g., LD.6500 or LA.7000.0).

